

modular WALL CLAD INSTALLATION



Vertical or Horizontal Mounting



VERTICAL MOUNTING

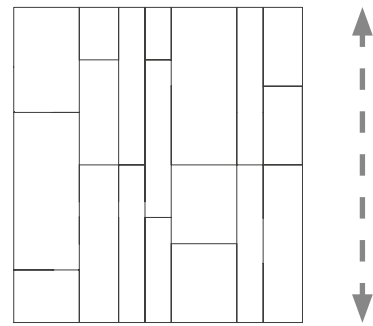

VERTICAL MOUNTING

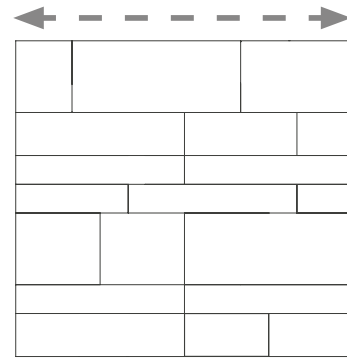
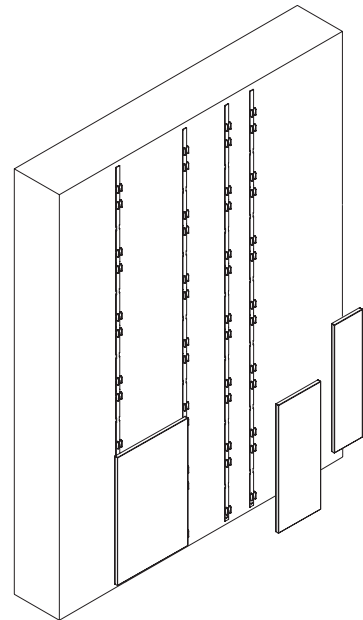

HORIZONTAL MOUNTING

OR

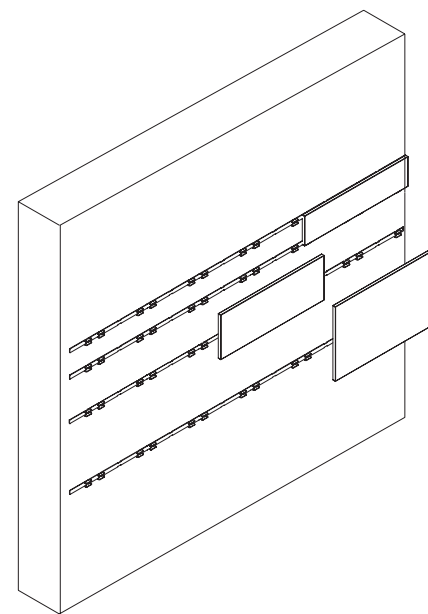

HORIZONTAL MOUNTING

Installation Overview

PANEL HAS SLOTS ON BACK FOR EASY AND FAST INSTALLATION



LINE UP SLOTS AND INSERT PANEL

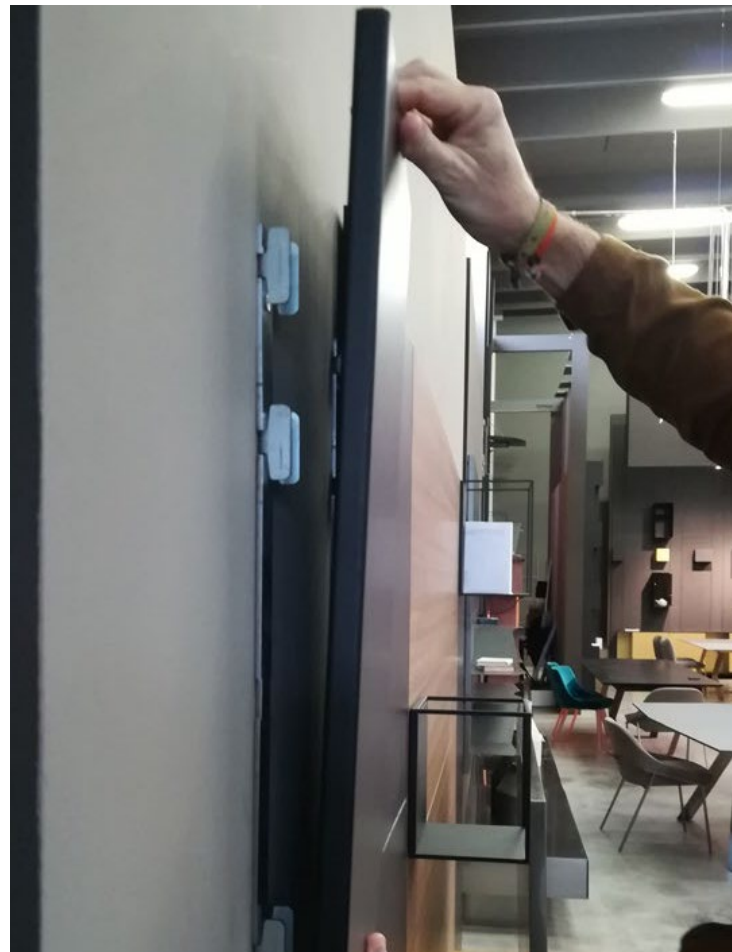

SEAMLESSLY ARRANGE WALL CLAD MATERIALS

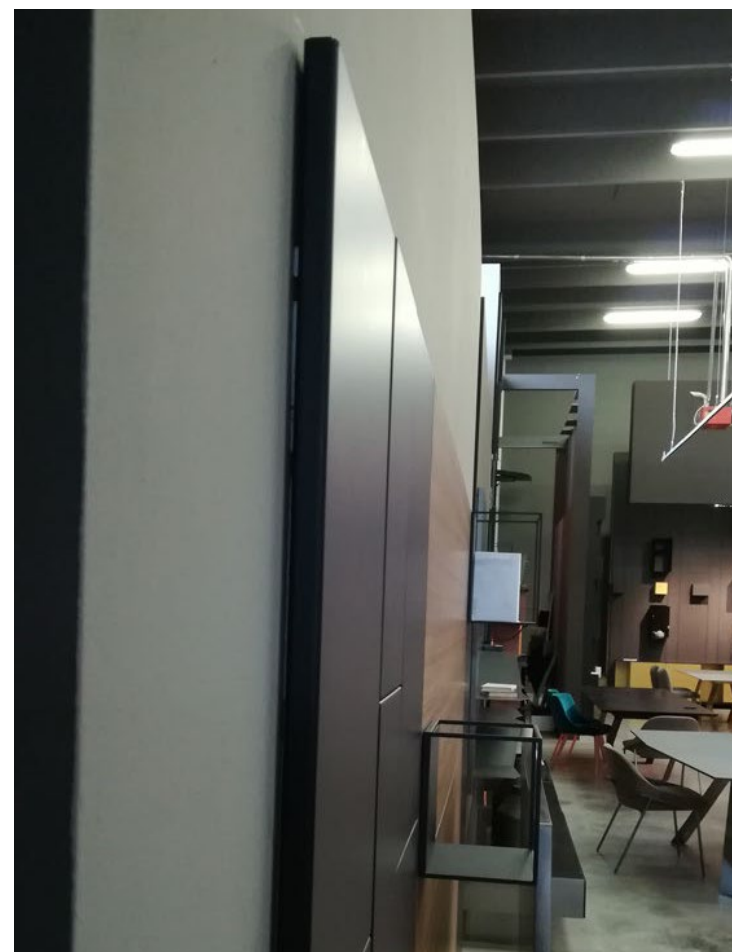

ENJOY YOUR CUSTOM WALL!

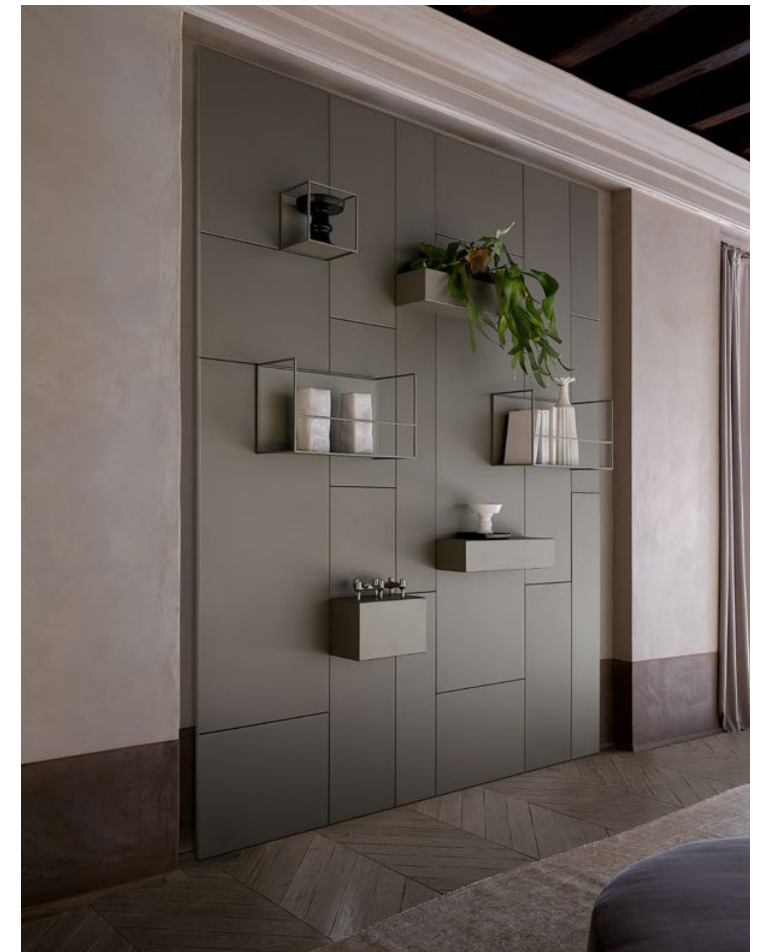

Installation Instructions

COMPONENTS

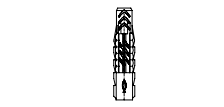

WALL ANCHOR



SCREW

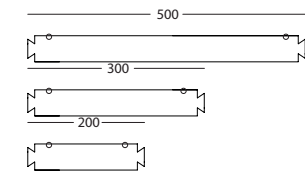

SPACER



JOINT



PANEL

MOUNTING OPTIONS

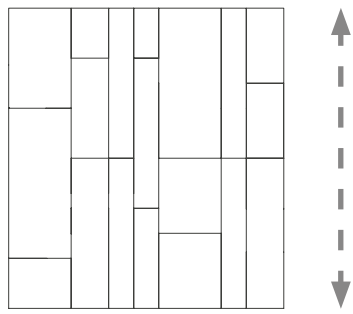

VERTICAL

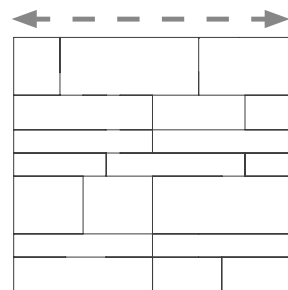

HORIZONTAL

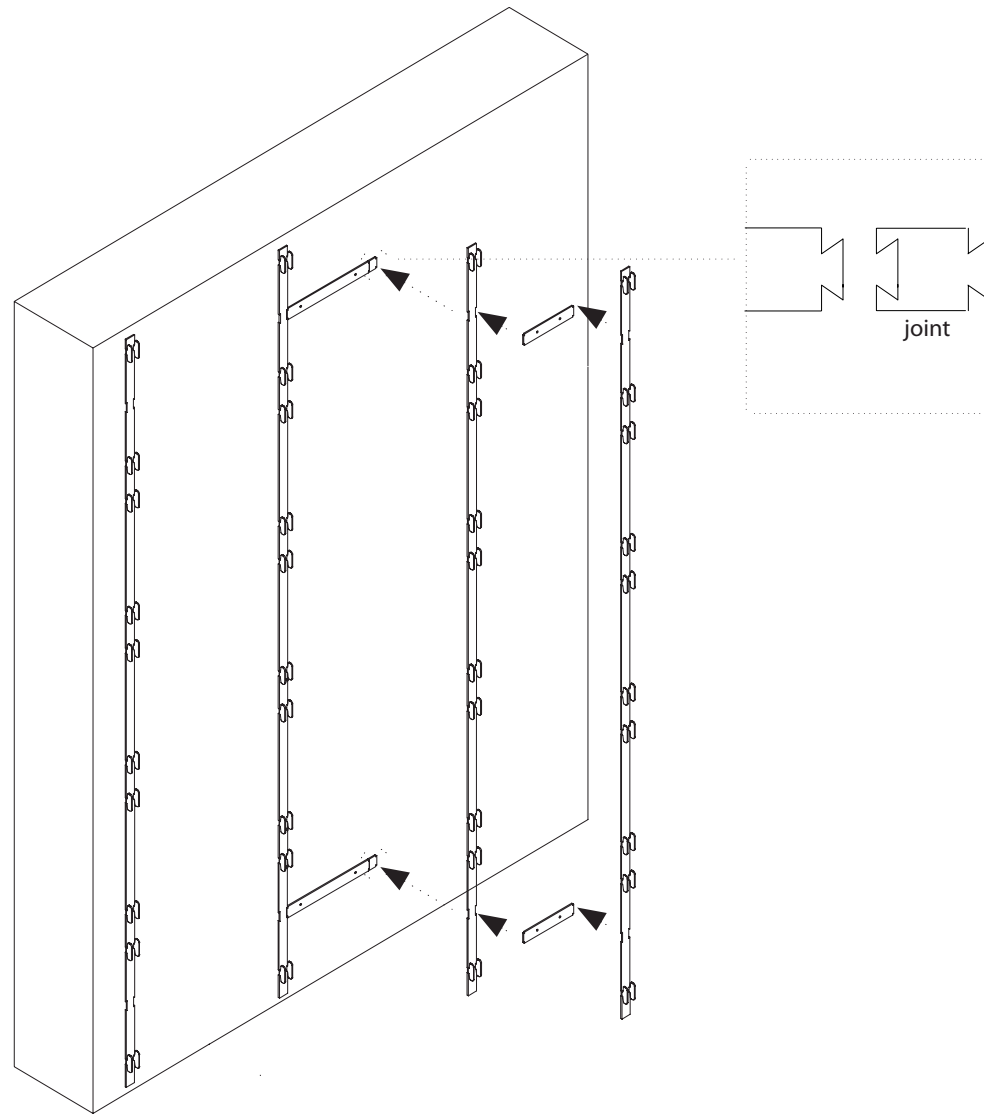

STEP 1:

- Mechanically fasten mounting strips to finished wall using a leveler
- Insert pre-fabricated spacers into joints to correctly distance mounting strips to each other.

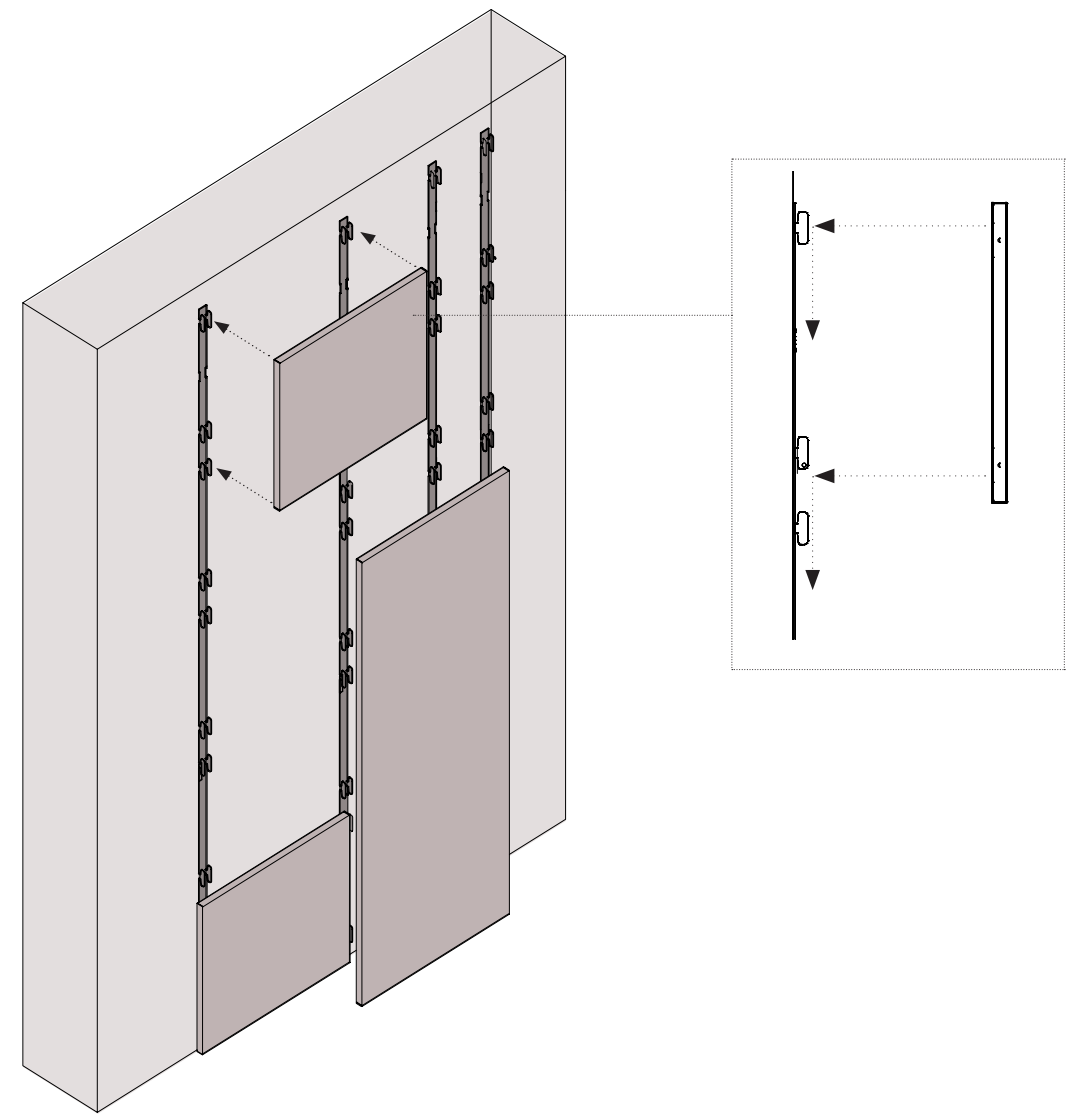

STEP 2:

- Push panels into mounting strips and push down. Installation complete.

Vertical Installation Instructions

REQUIRED TOOLS



INCLUDED PARTS

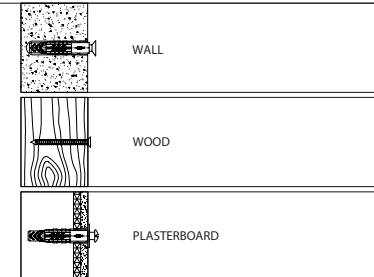
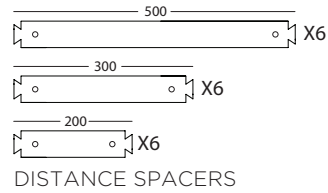
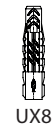

01

MINIMUM 3 SCREWS PER RACK

Ø8
UX8
5x60

PLACE THE END OF THE SUPPORT TRACK THAT HAS A SQUARE HOLE AT THE BOTTOM

02

! >2cm (13/16") FROM CEILING TO TOP OF SUPPORT TRACK

90°
INTERLOCK THE SPACER

03

Ø8
UX8
5x60

SPACERS: X2 UP TO HEIGHT 2000mm (122")
X3 HEIGHT > 2000mm (122")

REMOVE THE SPACERS AFTER MOUNTING THE SUPPORT TRACK

04

JOINT

ADD JOINTS TO DISTANCE SPACERS FOR CENTRAL PANELS (NO ADDED JOINTS ON END PANELS)

05

06

3
2
1

PLACE BOTTOM PANELS FIRST AND WORK UPWARDS TO THE TOP

07

Horizontal Installation Instructions

REQUIRED TOOLS



INCLUDED PARTS

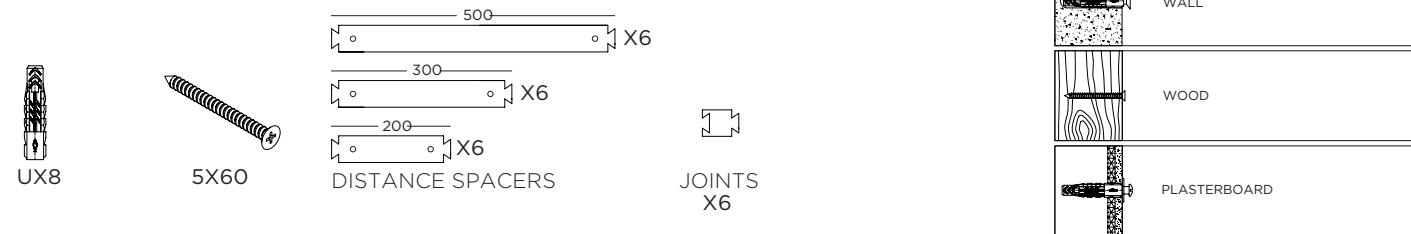

01

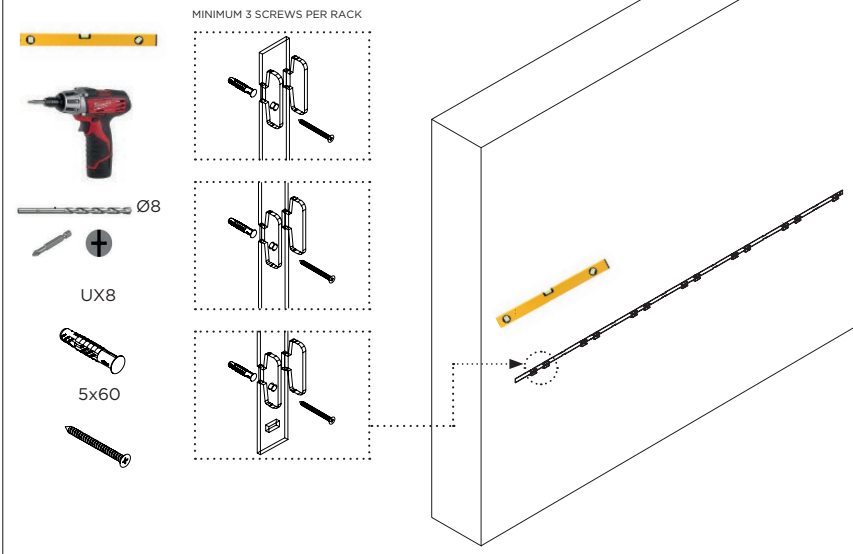

02

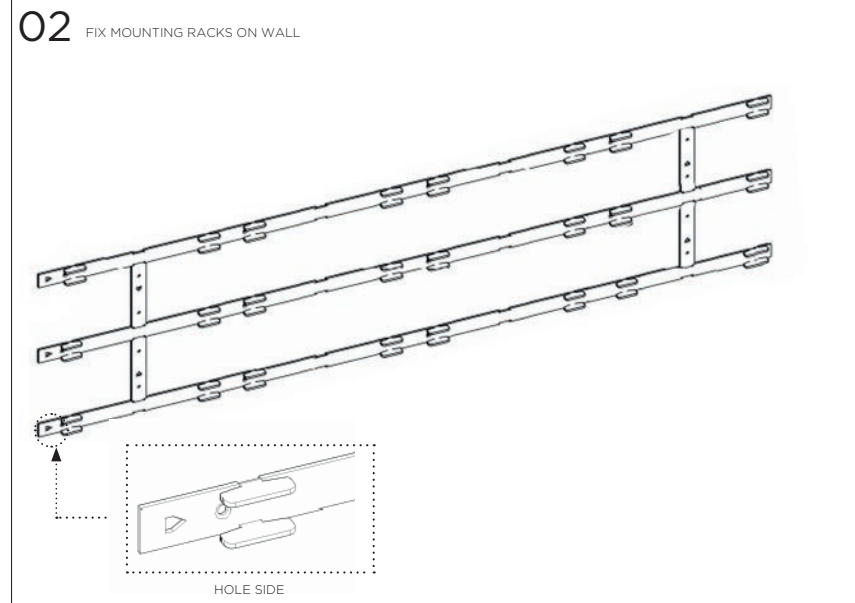

03

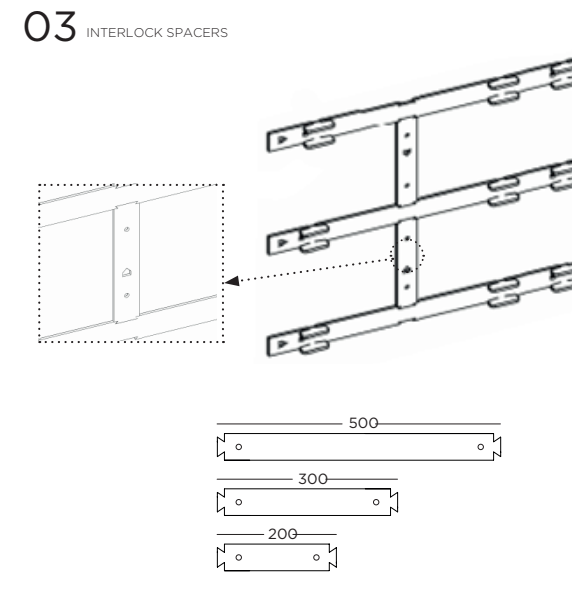

04

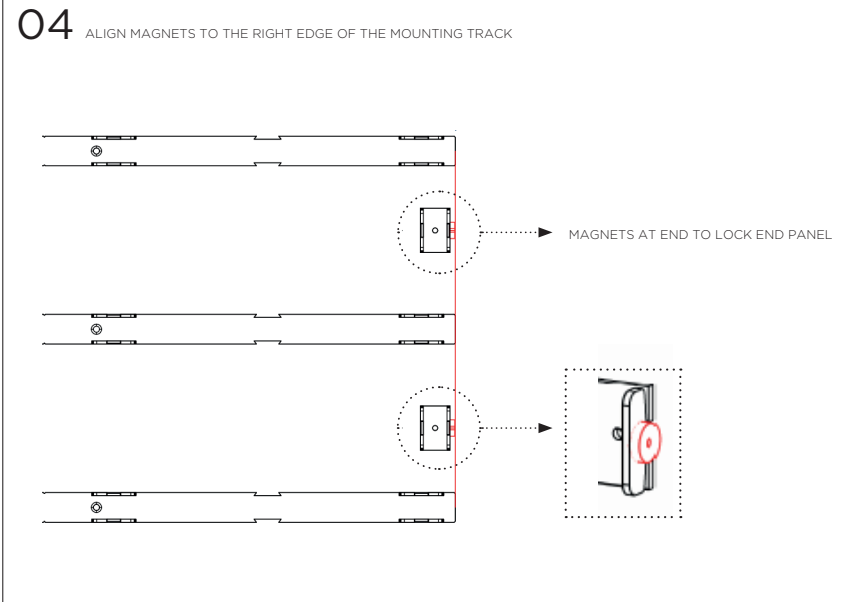

05



06

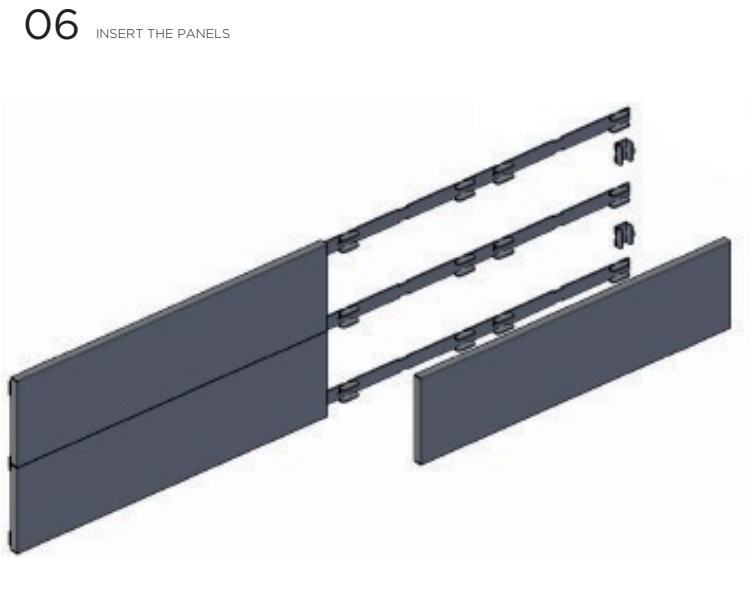

CARVART®