

FRAMELESS SLIDING DOOR INSTALL INSTRUCTIONS

DISCLAIMER:

All instructions shown are intended to show sequence of installation only. Installers are responsible for means and methods of installation. CARVART is not responsible for the quality of substrate materials and means & methods of installation. The site should be fully cleaned and free of general and air-borne debris.

COMPONENTS:

Prior to the start of installation, all delivered material should be fully inspected for damage and missing or incorrect materials. This should be cross-checked with the bill of lading and reported within 48 hours of delivery. Any damage or missing materials reported after 48 hours will be the responsibility of the receiving party.

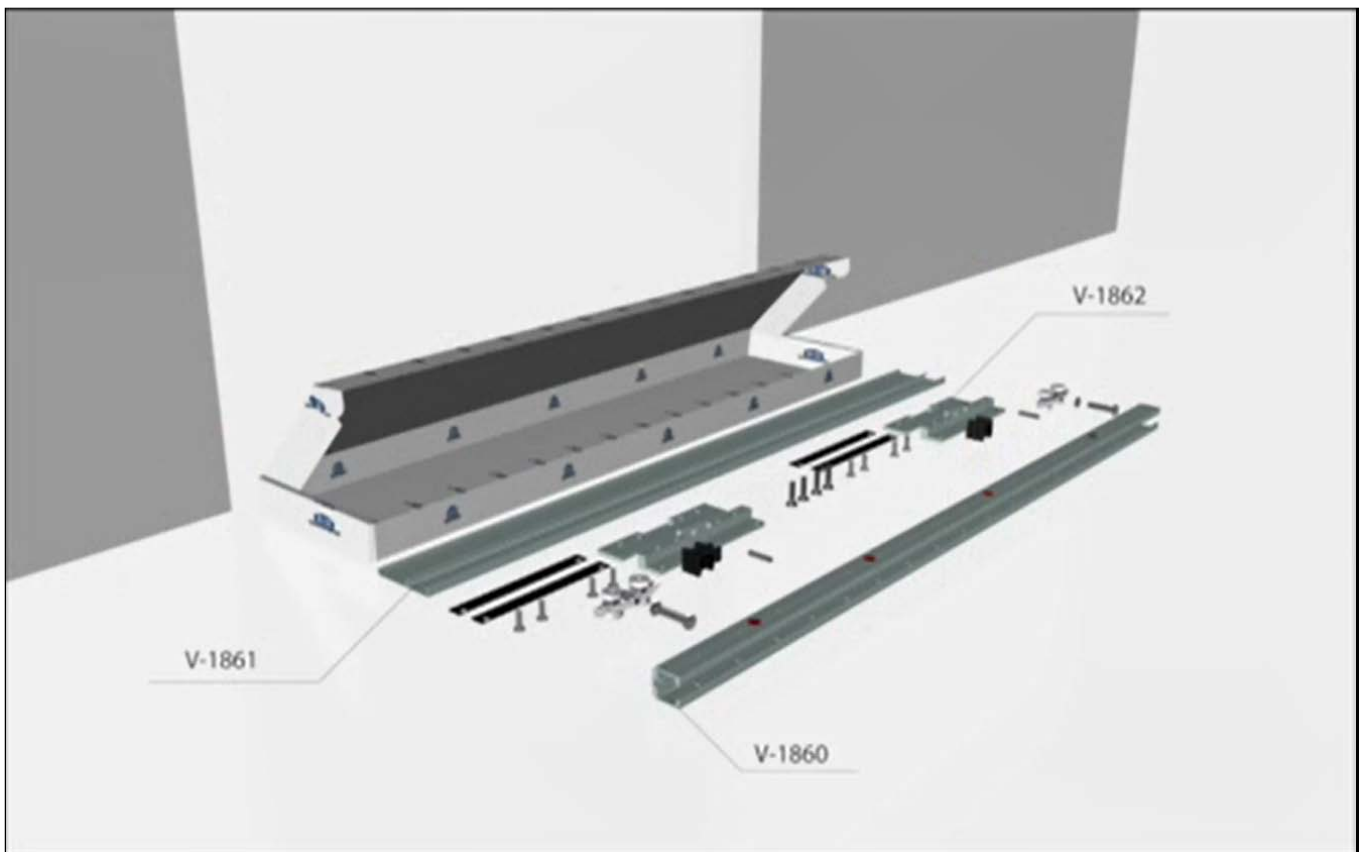

FRAMELESS SLIDING DOOR INSTALL INSTRUCTIONS

STEP ONE:

Place track on wall or ceiling and fasten. Prepare dolly for insertion.

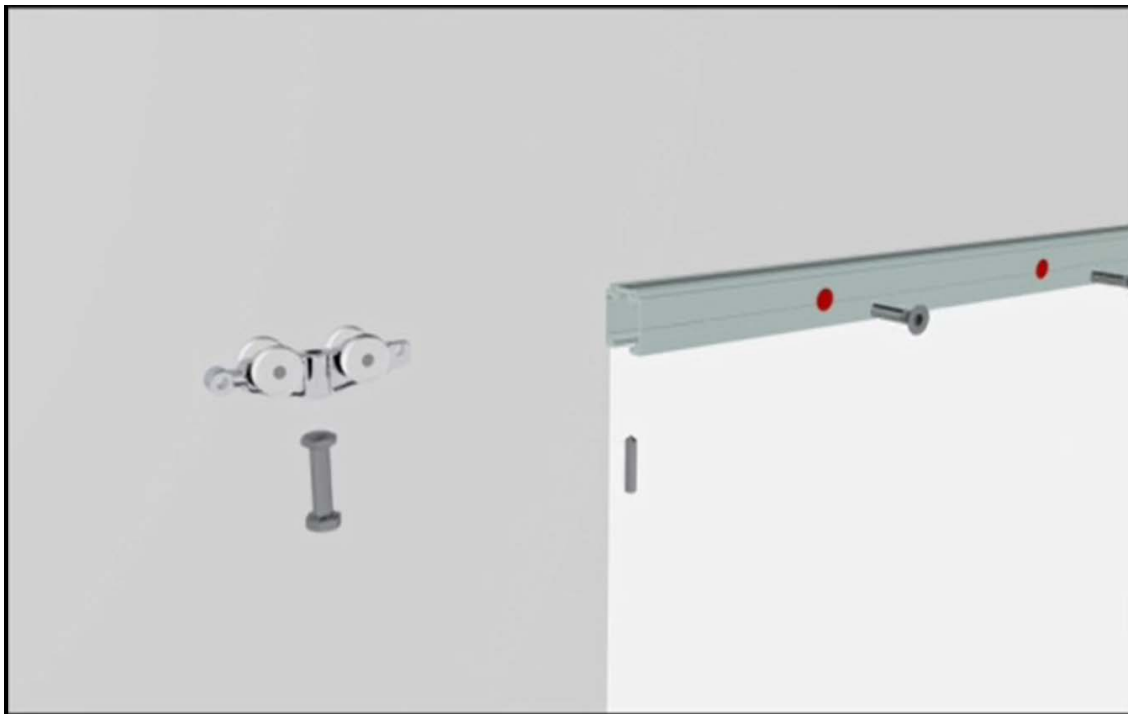

STEP TWO:

Insert dolly into track.

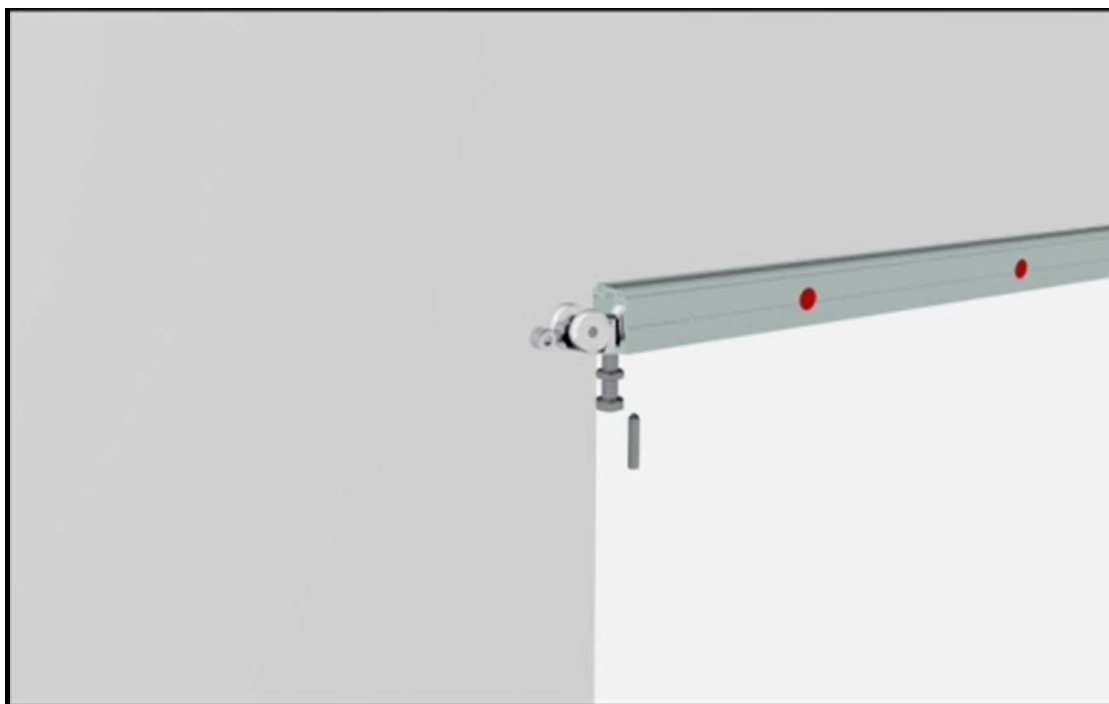

FRAMELESS SLIDING DOOR
INSTALL INSTRUCTIONS

STEP THREE:

Insert door stop into required location and insert pin.

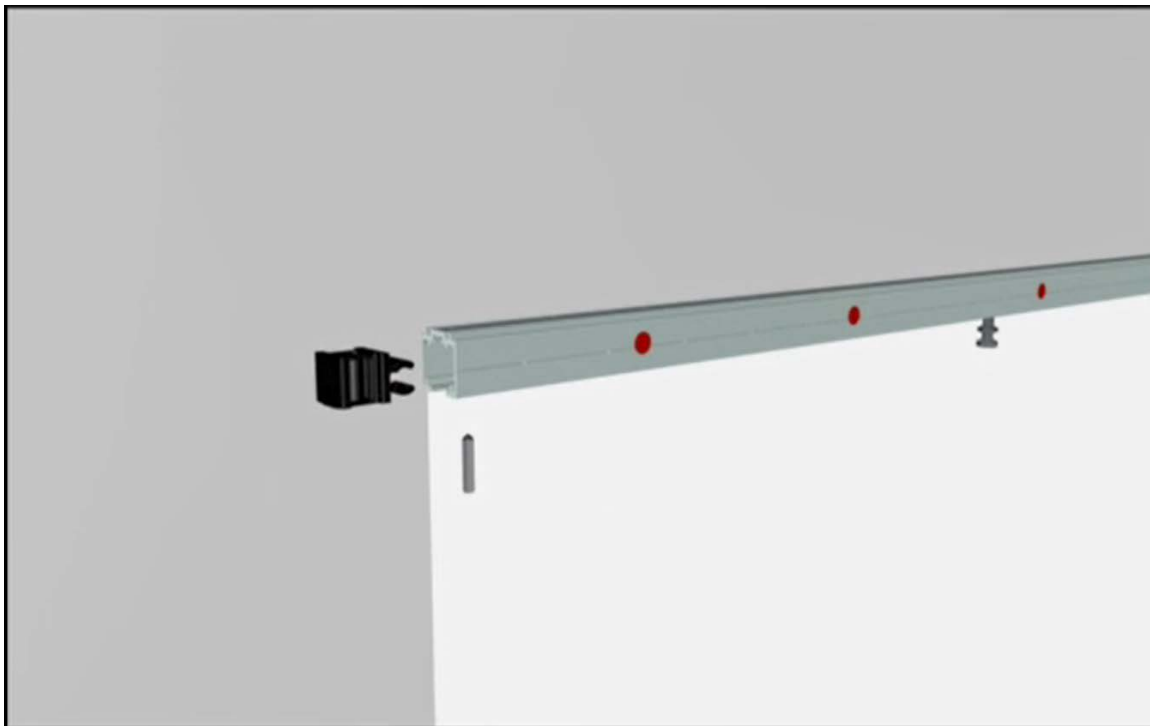

STEP FOUR:

Repeat with other door stop.

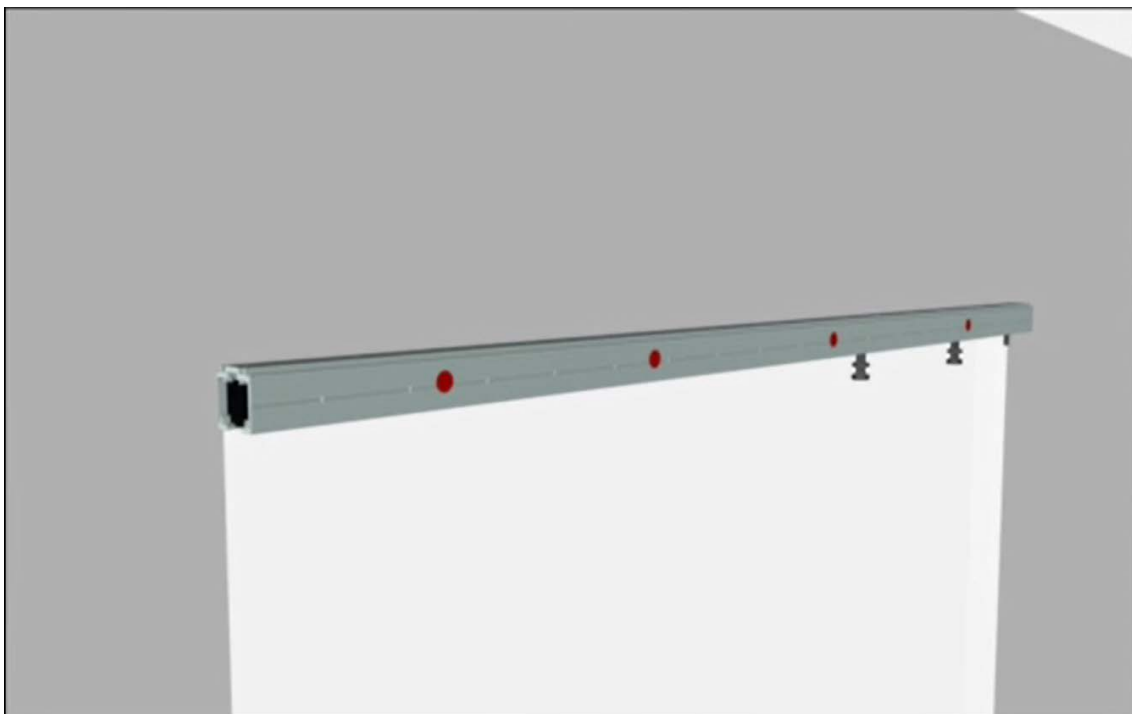

FRAMELESS SLIDING DOOR INSTALL INSTRUCTIONS

STEP FIVE:

Assemble components for glass clamp. Both parts of the clamp must be completely parallel and the correct metal spacers must be used depending on the glass thickness. If the clamps are not parallel, the glass will fall out.

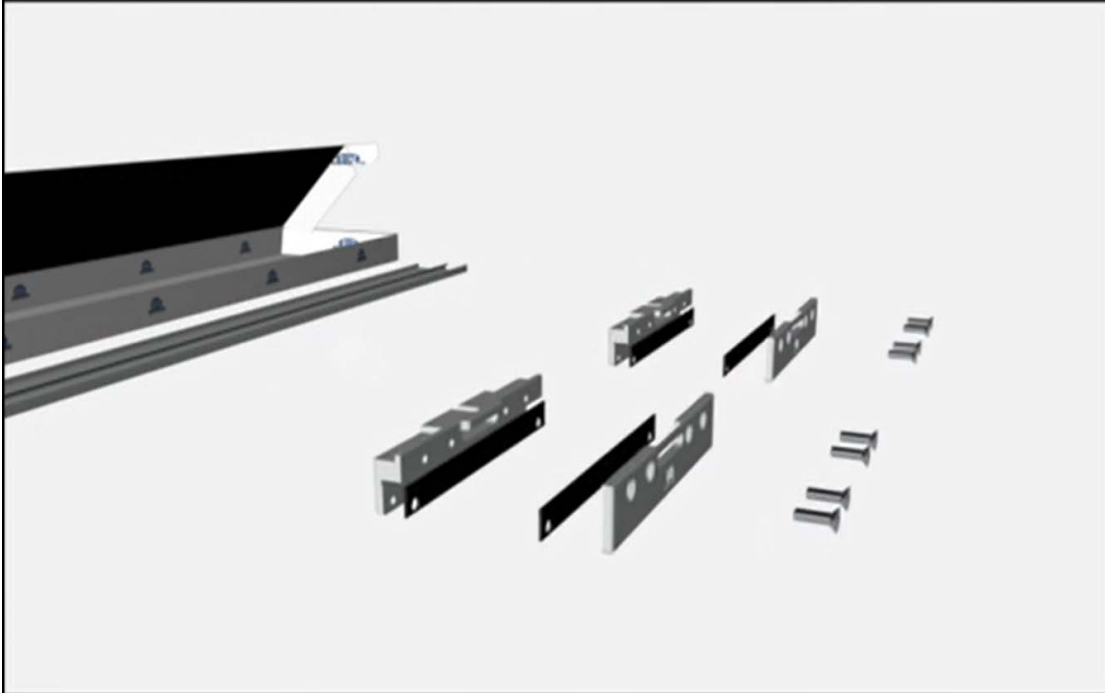

STEP SIX:

Insert glass and fasten. (Make sure to check glass type / thickness - this system accepts 3/8" max.)

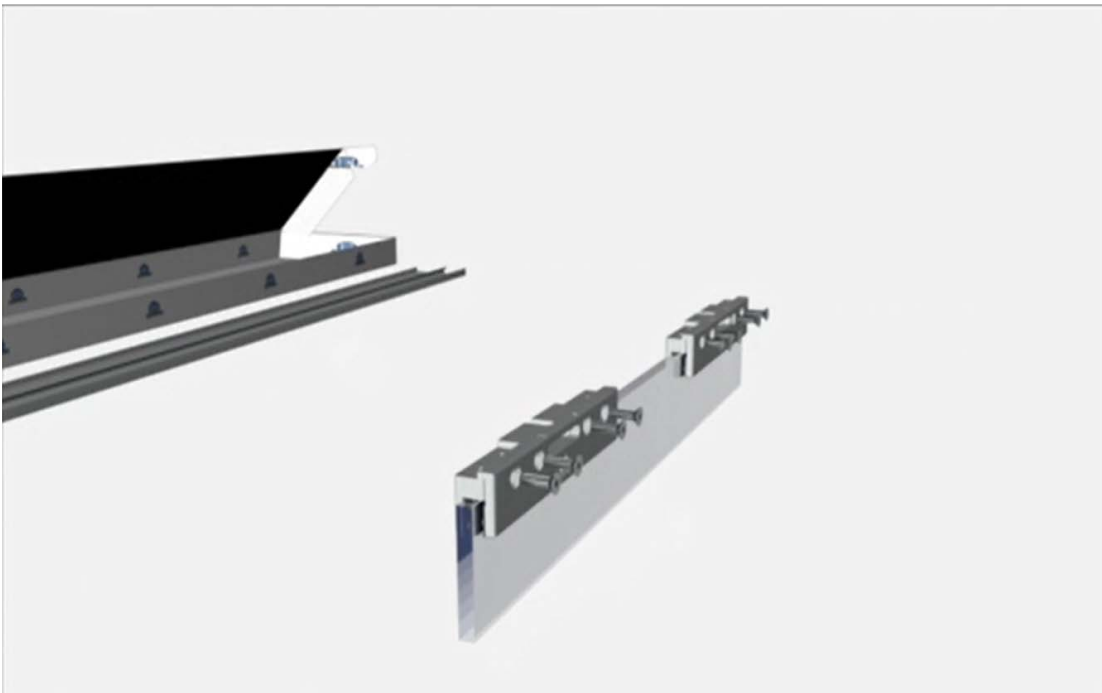

FRAMELESS SLIDING DOOR
INSTALL INSTRUCTIONS

STEP SEVEN:

Attach glass to track.



STEP EIGHT:

Adjust glass to proper level.

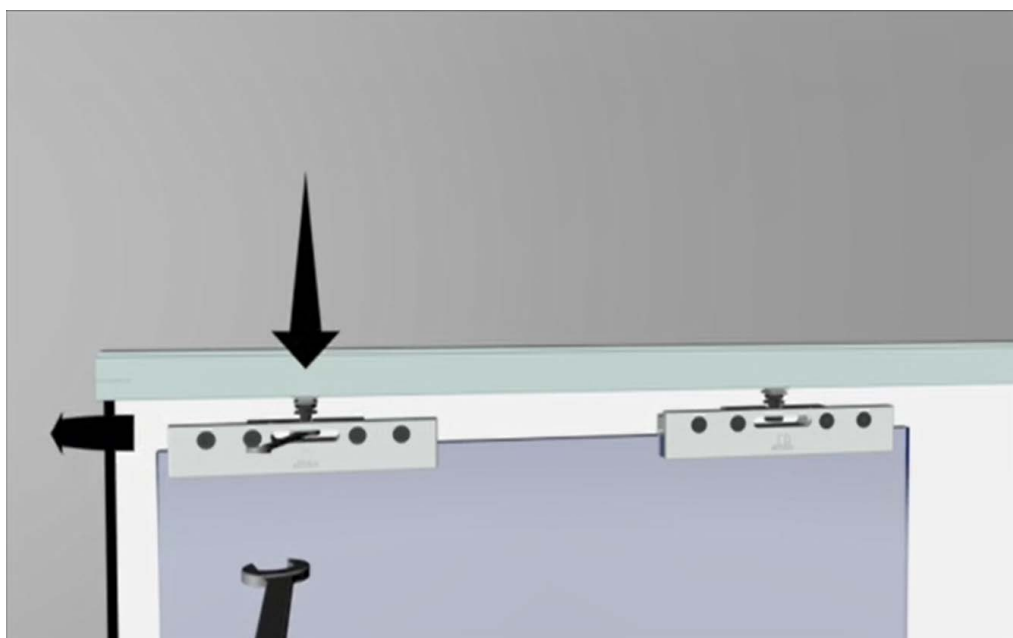

FRAMELESS SLIDING DOOR
INSTALL INSTRUCTIONS

STEP NINE:

Fasten.



STEP NINE:

Insert clips into fascia.

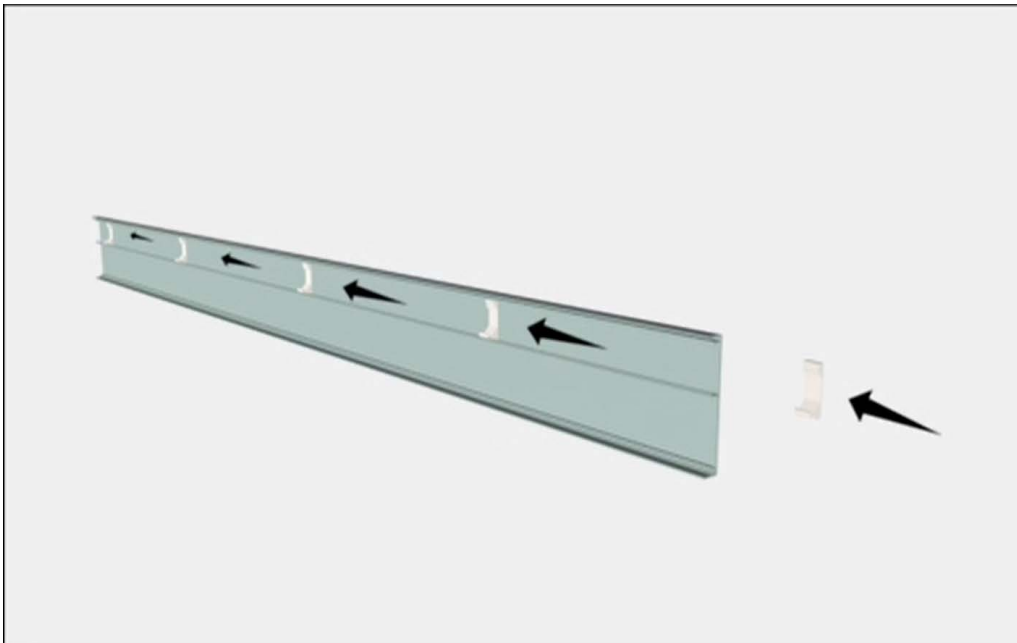

FRAMELESS SLIDING DOOR INSTALL INSTRUCTIONS

STEP TEN:

Snap fascia onto track before end cap.



STEP ELEVEN:

Snap end cap onto track.

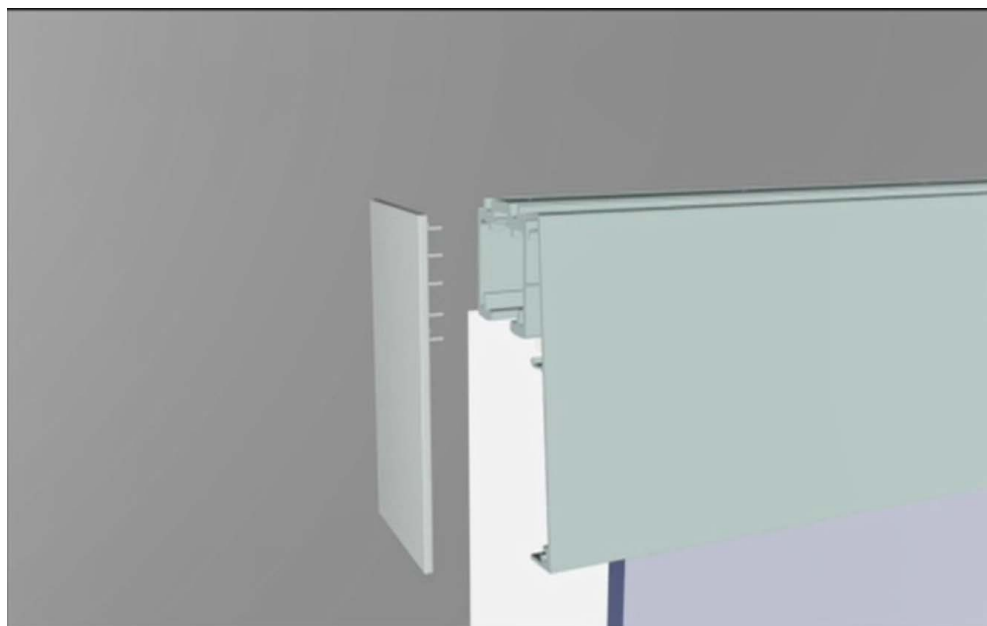

FRAMELESS SLIDING DOOR
INSTALL INSTRUCTIONS

STEP TWELVE: Install floor guide

A. Insert bolt.

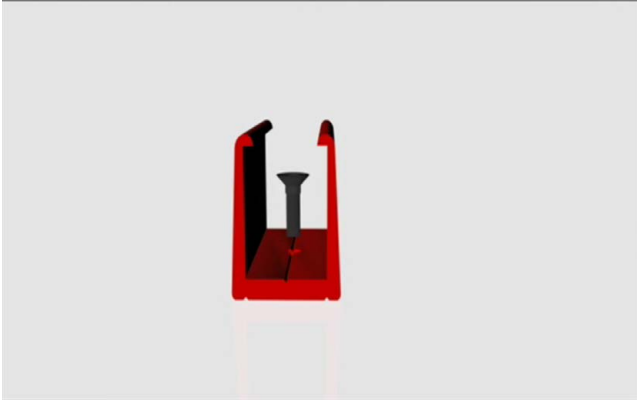

B. Insert gaskets.

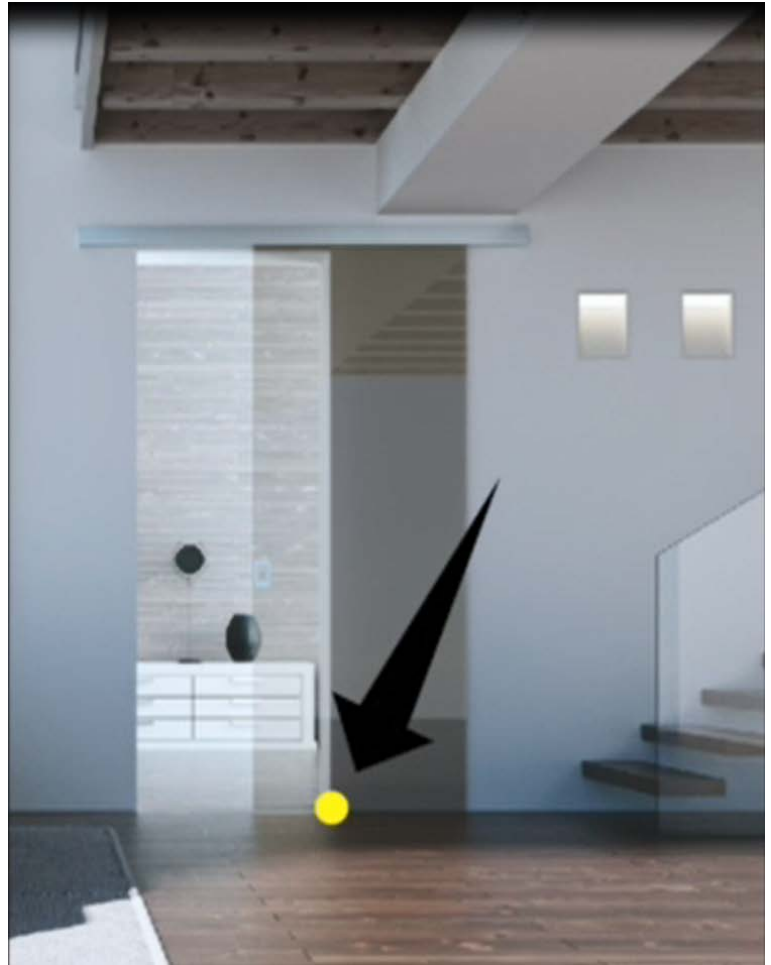
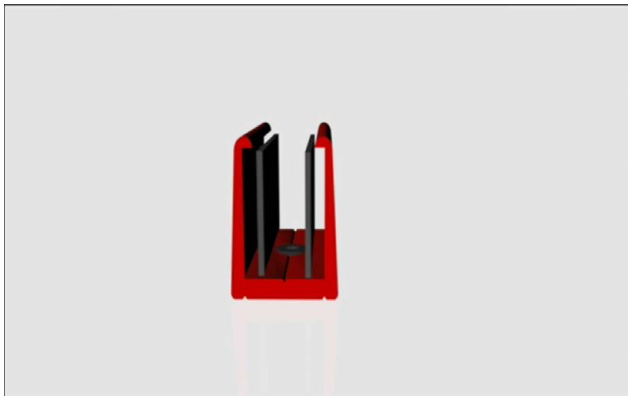

C. Slide glass through floor guide.

